

Real-Time Color Quad Processor

User's Manual

CONTENTS

0. CONTENTS	1
1. INTRODUCTION AND FEATURES	2
1.1 Product Introduction.....	2
1.2 Product Features.....	2
2. INSTALLATION	3
2.1 System Installation Diagram.....	3
2.2 Installation Procedures.....	3
2.3 Illustrate of installation procedures.....	4
3. OPERATING INSTRUCTIONS	7
3.1 Introduction of the MASTER CONTROL panel.....	7
3.2 Operating instructions.....	8
3.2.0 Power On Reset and System Self-Test.....	8
3.2.1 NORMAL DISPLAY MODE.....	8
3.2.2 SEQUENCE MODE.....	9
3.2.3 PLAYBACK MODE.....	9
3.2.4 SYSTEM SETUP.....	10
3.2.4.1 SYSTEM SETUP DESCRIPTION.....	10
3.2.4.2 DATE/TIME SETUP.....	10
3.2.4.3 DISPLAY SETUP.....	12
3.2.4.4 TITLE SETUP.....	12
3.2.4.5 MOTION SETUP.....	13
3.2.4.6 PIP/POP SETUP.....	14
3.2.4.7 LOAD DEFAULT & WATCH ALARM LIST.....	15
4. WARNING	16
5. SPECIFICATIONS	17

Version:

2004-03-15 version 1.0

2005-01-17 version 1.1

2005-09-06 version 1.2

The author assumes no responsibility for any errors or omissions, which may appear in this document, nor does he make a commitment to update the information contained herein.

Third-party brands and manes are the property of their respective owners.

Printed in Taiwan.

1. INTRODUCTION AND FEATURES

1.1 Product Introduction

This surveillance kit can be installed in many different places (such as homes, shops, offices, etc.). It is designed with 4 objectives : Economical, Complete Functions, Installed Easily, and User Friendly.

1.2 Product Features

- An economic solution for home, shop or building surveillance system.
- Plug & Play. Installs easily and is suitable as DIY (Do It by Yourself).
- Equipped with Microprocessor, compact dimension, and smart functions. Simple operation mode and user-friendly design.
- Full quad display at real time refreshes rate. (NTSC : 60 Fields / sec : PAL : 50 Fields / sec)
- Under Power on Reset cycle, both NTSC and PAL systems are supported by automatic smart detection and master video setting format.
- Built-in Buzzer for video loss, and motion events alarm.
- Built-in a Real-Time-Clock (RTC) with OSD IC that can show date and time.
- User-friendly On-Screen-Display (OSD) set-up menu and front panel design.
- Borderline adjustment: nine colors and two borderline widths.
- Supports Motion detection for each channel in QUAD / FULL DISPLAY MODE.
- Each channel enables up to 8 independent character title settings.
- Provides VCR-IN to support 2×2 Zoom-in and Freeze function for playback.
- Automatic video loss detection – it triggers alarm and shows messages on the monitor when video input loss occurs.
- Built-in four independent digital adjustments: bright, contrast and hue.
- Built-in Color-Bar generator that enables easy monitor calibration.
- Supporting adjustment: nine OSD color characters.
- Supports Quad screen / Full screen / PIP / POP / Auto-Sequential / Play-Back display modes.
- Supporting smart automatic switcher allows random sequence and programmable dwelling time.
- Automatically detects unconnected channel and skips that channel in auto-switch mode.
- Supports an alarm-triggered relay output (RELAY OUT) that can control other security systems, related electric devices or to start VCR recording.
- 40 alarm record and list occurrences.
- Low power consumption saves up to 50% in power costs.

2. INSTALLATION

2.1 System Installation Diagram

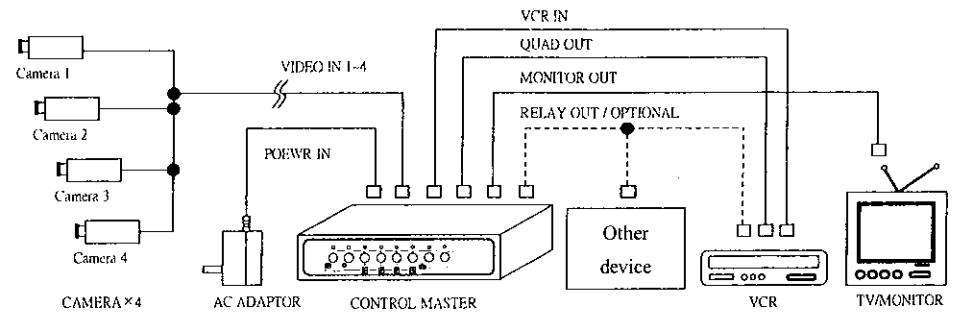



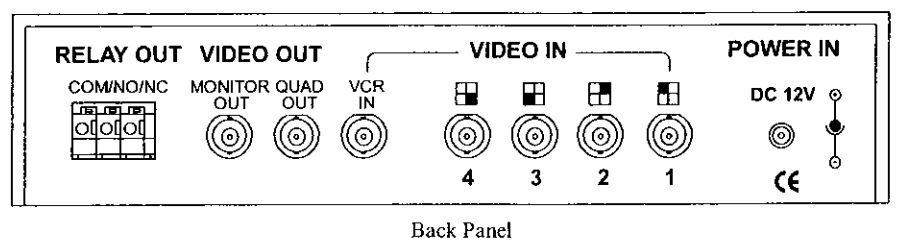



2.2 Installation Procedures



Terminal Function Description.

Terminal	Function Description
 DC 12V DC Power Input Jack	The DC POWER INPUT terminal : 12Vdc±10%.
 COM/NO/NC Alarm Triggered Relay Out & Alarm Trigger Input Terminal	It supports auto-switch output (N.O., Normal Open type or N.C., Normal Close type), and external alarm trigger input function. It is applied to control other equipments, when an alarm has been triggered.
 MONITOR OUT Video signal output BNC type Terminal	This terminal represents the video signal output for connecting to external Monitors.

Terminal	Function Description
 <p>Video signal output BNC type Terminal</p>	This terminal represents the video signal output for connecting to external VCR.
 <p>External video signal input BNC type Terminal from the VCR</p>	This terminal represents the video signal input for connecting to external VCR.
 <p>CH1 video signal input BNC type Terminal</p>	This terminal represents the video signal input for connecting from external camera.
 <p>CH2 video signal input BNC type Terminal</p>	This terminal represents the video signal input for connecting from external camera.
 <p>CH3 video signal input BNC type Terminal</p>	This terminal represents the video signal input for connecting from external camera.
 <p>CH4 video signal input BNC type Terminal</p>	This terminal represents the video signal input for connecting from external camera.

2.3 Illustrate of installation procedures :

Step 1: Figure below shows Illustrations of the external video Cameras, Monitor and VCR:

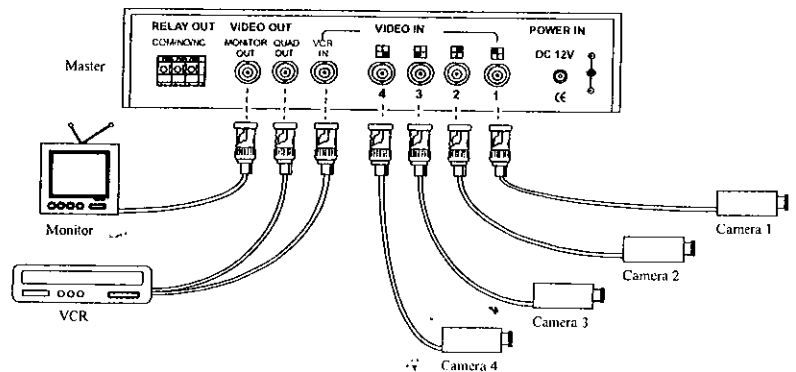

Step 2: This step is unessential, when controlling of other equipment through the MASTER CONTROL is unnecessary.

Item	Diagram	Setup Expatiation
2.3.3-a	<p>φ 2.3 mm Max.</p> <p>SOLID WIRE</p> <p>8.50 mm</p> <p>OR</p> <p>STRANDED</p>	<p>Specifications of the Connector Wires :</p> <ul style="list-style-type: none"> ◆ Insulator stripped off length : 8.5 +0.5 / -1.5mm ◦ ◆ Maximum gauge : φ=2.3mm (14~24AWG) ◦
2.3.3-b	<p>RELAY OUT</p> <p>COM / NO / NC</p> <p>From VCR ect</p> <p>OR</p>	<p>Connect the external VCR system line (External VCR Start Record) into the RELAY OUT terminal.</p> <p>(※ Please check your Time-Lapse VCR user's manual for configurations on "RELAY OUT" terminal connections. Please take note on COM-N.O. and COM-N.C. !)</p>

Shown below is the illustration of CCTV/VCR setup - "RELAY OUT" port may also be used in controlling devices such as security main controller or auto-dialing machine, etc.

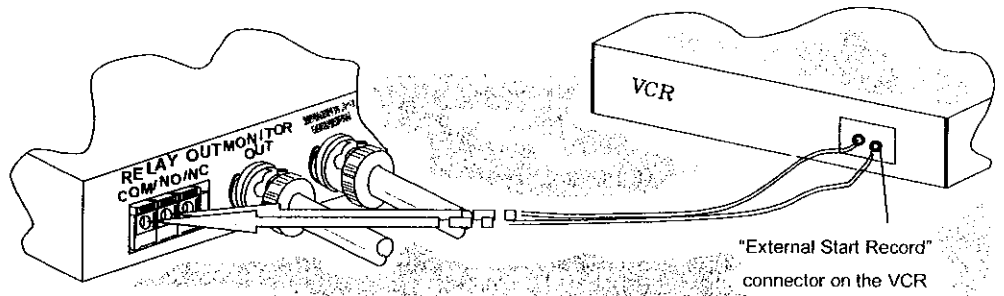

Ⓛ Attention ! The max current and voltage type are DC24V-2Amp or AC120V-1Amp for RELAY OUT.

Step 3: Plug one end of the power adaptor into the "DC IN" socket and the other end into the AC power socket as shown below, to enable this whole surveillance system to work perfectly.

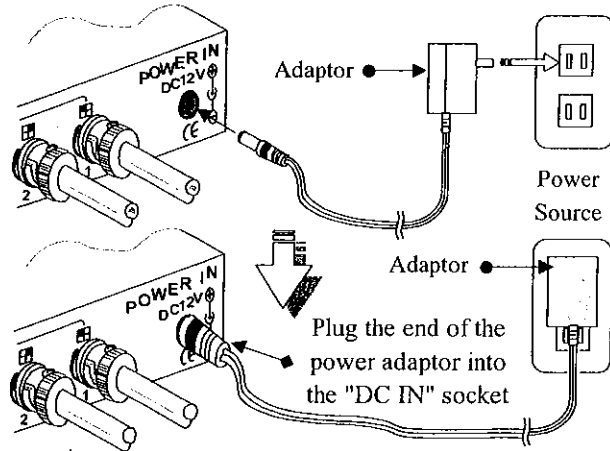

Step 4: To disconnect RELAY OUT terminal wires, Please follow the instructions below :

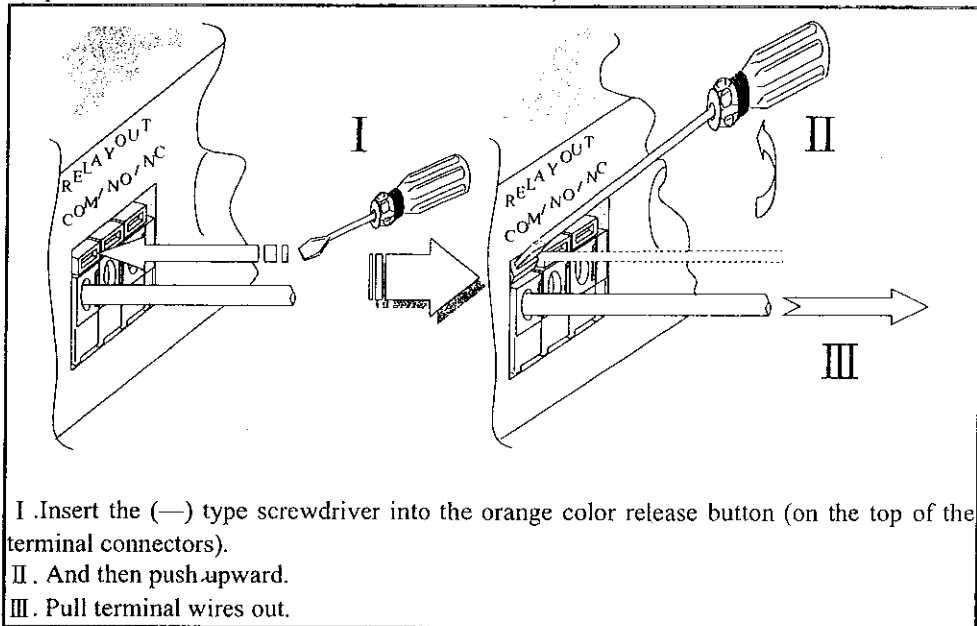

3. OPERATING INSTRUCTIONS

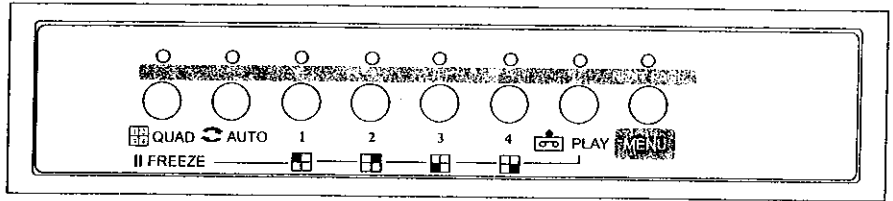

3.1 Introduction of the MASTER CONTROL panel



Front Panel

◆ Operation Key Function Descriptions.

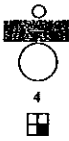
Mode Light	Normal Mode	FREEZE	AUTO Seq. Mode	PLAYBACK Mode	PLAYBACK FREEZE Mode	MENU Mode
Key		QUAD LED flash	AUTO LED light	PLAY LED light		MENU LED light
	QUAD LED light	QUAD LED light	QUAD LED light	QUAD LED light		
QUAD FREEZE	Enter to QUAD Display mode.	Disengage from image freeze mode.	(AUTO LED dark) Back to normal QUAD display.	Enter to Full playback image.	Freeze / Release Full playback image.	
	AUTO LED light		QUAD LED light			
AUTO	Enter to AUTO Sequential mode.		(AUTO LED dark) Back to normal QUAD display.			
	1 LED light	1 LED light or dark	1 LED light	1 LED light	1 LED light	
1 	CH1 Full display.	Freeze / Release CH1 image.	(AUTO LED dark) Back to normal CH1 Full display.	Enter to 2×2 image display of quadrant 1.	Freeze / Release 2×2 image of quadrant 1.	Change to left field. ◀
	2 LED light	2 LED light or dark	2 LED light	2 LED light	2 LED light	
2 	CH2 Full display.	Freeze / Release CH2 image.	(AUTO LED dark) Back to normal CH2 Full display.	Enter to 2×2 image display of quadrant 2.	Freeze / Release 2×2 image of quadrant 2.	Change to right field. ▶
	3 LED light	3 LED light or dark	3 LED light	3 LED light	3 LED light	
3 	CH3 Full display.	Freeze / Release CH3 image.	(AUTO LED dark) Back to normal CH3 Full display.	Enter to 2×2 image display of quadrant 3.	Freeze / Release 2×2 image of quadrant 3.	Increase value. +

Mode Light	Normal Mode	FREEZE	AUTO Seq. Mode	PLAYBACK Mode	PLAYBACK FREEZE Mode	MENU Mode
Key		QUAD LED flash	AUTO LED light	PLAY LED light		MENU LED light
	4 LED light CH4 Full display.	4 LED light or dark Freeze / Release CH4 image.	4 LED light (AUTO LED dark) Back to normal CH4 Full display.	4 LED light Enter to 2×2 image display of quadrant 4.	4 LED light Freeze / Release 2×2 image of quadrant 4.	Decrease value. —
	PLAY LED light Enter to VCR PLAYBACK mode.		PLAY LED light (AUTO LED dark) Enter to VCR PLAYBACK mode.	PLAY LED dark Disengage from VCR PLAYBACK mode.		
	MENU LED light Enter to Menu set-up mode.		MENU LED light (AUTO LED dark) Enter to Menu set-up mode.			MENU LED light To Next Page or Disengage from Menu mode. (MENU LED dark)

3.2 OPERATING INSTRUCTIONS

3.2.0 Power On Reset and System Self-Test.

Each time during Power On (Plug In), the master controller starts up with the procedure of warming-up and self-testing.

Normally video input detection format starts from CH1 to CH4. When CH1 is unconnected, video input detection skips CH1 and starts from CH2 to CH4 and so forth.

- After POWER ON and when no cameras have been connected, the "NO VIDEO" message will be shown on the monitor.
- After POWER ON and the cameras have been connected, but any sudden disconnection after POWER On will automatically trigger the alarm, and the "LOSS" message will be shown on the monitor.

3.2.1 NORMAL DISPLAY MODE.

- **FULL SCREEN DISPLAY** : Displays Channel 1~4 on the monitor, by pressing the function key of [1~4] to display images from Channel 1~4.
- **QUAD SCREEN DISPLAY** : Press { QUAD }, monitor will show images by quad from Channel 1~4.

- FREEZE mode : press [QUAD] key again when QUAD LED is turned on in Normal mode. Then the QUAD LED will flash until the processor returns to Normal mode.
- FREEZE the Channel : Press key [1 ~ 4], the 1~4 LED will turn on and freeze the image. To unfreeze-press [QUAD] key again or wait after the FREEZE HOLD TIME period you set elapse.
- PIP / POP DISPLAY : Displays Channel 1~4 PIP or POP on the monitor, by pressing the function key of [1~4] to display images follower the PIP / POP display setup (please refer to page14 PIP / POP setup).

3.2.2 SEQUENCE MODE.

- Press the [AUTO] key to enter AUTO SEQUENCE mode. The processor automatically changes to the image, interval time and channels previously setup.
- ◆ Under AUTO SEQUENCE MODE, when no sequence has been set, the "NO SEQUENCE SETTING" message will be shown on the monitor.
- ◆ Under AUTO SEQUENCE MODE, when all dwell time are set to 0, the "NO SEQUENCE TIME SETTING" message will be shown on the monitor.
- ◆ Under AUTO SEQUENCE MODE, when no sequence video input has been set, the "NO SEQUENCE VIDEO INPUT" message will be shown on the monitor.
- ◆ Under AUTO SEQUENCE MODE, when more than one settings (e.g. no sequence and all dwell time set to 0) are made simultaneously, the "SEQUENCE SETTING ERROR" message will be shown on the monitor.
- By pressing any key in the AUTO SEQUENCE MODE, processor will automatically return to NORMAL DISPLAY MODE.

3.2.3 PLAYBACK MODE.

- Press the [PLAY] function key, it will then enter to the VCR PLAYBACK MODE, and the "VCR PLAY" message will be shown on the monitor. **In the VCR PLAYBACK MODE, the VCR OUT will change to mute (blue background) & stop to detect for the CH1~4 video loss until leave this mode!**
- When the VCR has been disconnected before entering the PLAYBACK MODE the alarm automatically goes ON, and the "NO VCR" message will be shown on the monitor and turn on beeper.
- When the VCR has been disconnected, after entering the PLAYBACK MODE the alarm automatically goes ON, and the "VCR LOSS" message will be shown on the monitor and turn on beeper.
- Press the [PLAY] function key again in the PLAYBACK MODE, the processor will then return to the NORMAL DISPLAY MODE.
- Press [QUAD] function key under VCR full screen image display, the processor will then freeze the full screen image of the VCR and the message "FREEZE" will be shown on the monitor. To unfreeze press [QUAD] function key again, or wait until the VCR freeze hold times up.

- Press key [1 ~ 4], processor will display 1 ~ 4 quadrant 2 × 2 zoom image. To release zoom display-press the { QUAD } key.
- Press key [1 ~ 4] again in 2 × 2 zoom image display, the processor will then freeze 1 ~ 4 quadrant 2 × 2 zoom image and the message "FREEZE" will be shown on the monitor. To unfreeze-press { QUAD } function key, or press key [1 ~ 4] again.

3.2.4 SYSTEM SETUP.

3.2.4.1 SYSTEM SETUP DESCRIPTION.

- ◆ Press the { MENU } function key to enter the MENU page (shown by Figure 1).
- ◆ Pressing the { ← } and { → } buttons to change the field left and right. By pressing it more then 1 sec., allows the field to change quickly left and right.
- ◆ Buttons { + } or { - } is used for increasing or decreasing a value. By pressing it more then 1 sec., allows the value to increase or decrease by more then one value.
- ◆ After the setting value has been finalized, press the { ← } and { → } buttons to change the field left and right or by pressing the { NEXT PAGE } key to disengage and to leave this setting page.

3.2.4.2 DATE / TIME SETUP

```

... DATE/TIMES SETUP ...
DATE FORMAT: YY.MM.DD
DATE: 2003.08.27
TIME: 12:35:50
LOCATION: BOTTOM
MONITOR OUT DATE\TIME: ON
VCR OUT DATE\TIME: ON
-- SEQUENTIAL SETTING --
SEQUENCE:
Q 1 2 3 4 . . .
DWELL TIME:
3 3 3 3 3 0 0

```

Figure 1.

- **DATE FORMAT** : There are three kinds of DATE format for display:

- ◆ ⇄YY . MM . DD⇄MM . DD . YY⇄DD . MM . YY⇄

```

(+) → YY . MM . DD (±) → MM . DD . YY (±) → DD . MM . YY ← (-)

```

Figure 2. DATE format with rolling mapping.

- **DATE range** : Year data from 2000 to 2099, Month data from 01 to 12, Day data from 01 to 30.
※ First time default is 2003 . 01 . 01
- **TIME format** : HH : MM : SS for display, Hour data from 00 to 23, Minute data from 00 to 59, Second data from 00 to 59.

om

ant
:SS

..

~

d

- **LOCATION** : There are six position for DATE / TIME display. On the LEFT TOP, TOP, RIGHT TOP, TOP, RIGHT BOTTOM, BOTTOM and LEFT BOTTOM. (First time default is BOTTOM!)

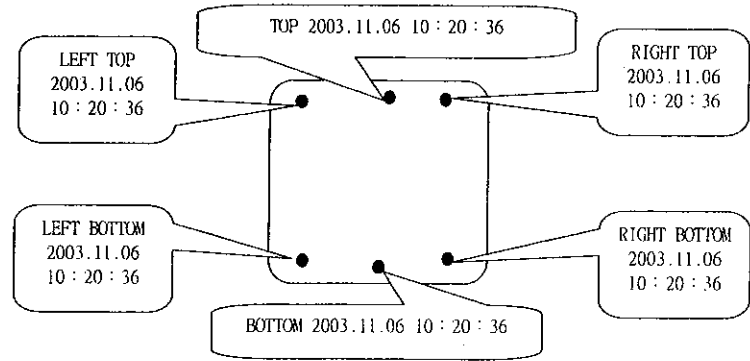

Figure 2. DATE \ TIME display location

- When the **MONITOR OUT DATE \ TIME** is set to "ON", the DATE\TIME will be shown on the MONITOR OUT display.
- When the **VCR OUT DATE \ TIME** is set to "ON", the DATE\TIME will be shown on the QUAD OUT display.
- **SEQUENCE** : There are eight positions to select and setup the random switching sequence.

Where : Q→QUAD display; 1→CH1 Full display; 2→CH2 Full display; 3→CH3 Full display; 4→CH4 Full display; . →Skip.

ⓈNOTICE :

☞ It automatically skips the channel in the auto-switch mode, when the channels are disconnected, and when video loss occurs.

☞ When no sequence are set on the AUTO SEQUENCE MODE, it will display "NO SEQUENCE SETTING" on the monitor, thus alerts the buzzer alarm.

- **DWELL TIME** : Set the interval time corresponding to each sequence position. (Time range : 0~9 seconds.)

ⓈNOTICE :

☞ When all dwell time are set to 0 on the AUTO SEQUENCE MODE, It will display "NO SEQUENCE TIME SETTING" on the monitor, thus alerts the buzzer alarm.

☞ When no sequence are set and all dwell time are set to 0 on the AUTO SEQUENCE MODE, It will display "SEQUENCE SETTING ERROR" on the monitor, thus alerts the buzzer alarm.

∴

3.2.4.3 DISPLAY SETUP.

CH1:		CH2:	
BRIGHT	64	BRIGHT	64
CONTRAST	64	CONTRAST	64
HUE	80	HUE	80
CH3:		CH4:	
BRIGHT	64	BRIGHT	64
CONTRAST	64	CONTRAST	64
HUE	80	HUE	80

Figure 3.

- **BRIGHT:** The camera 1~4 (channel 1~4) image brightness adjustable by user.
The brightness range: 0~99.
- **CONTRAST:** The camera 1~4 (channel 1~4) image contrast adjustable by user.
The contrasts range: 0~99.
- **HUE:** The camera 1~4 (channel 1~4) image HUE (color saturation) adjustable by user.
The HUE range: 0~99.

3.2.4.4 TITLE SETUP.

.... TITLE SETUP	
CH1:	ON CAMERA01
CH2:	ON CAMERA02
CH3:	ON CAMERA03
CH4:	ON CAMERA04
CHARACTER COLOR: WHITE	

Figure 4.

- When the **MONITOR OUT TITLE** is set to "ON", the title of the channel will be shown on the quadrant and on the full screen display.

- **CH 1~4 TITLE** : Can be set to any name within less then 8 characters.

※ · The 65 characters used in title settings are as follows:

↵0↵1↵2↵3↵4↵5↵6↵7↵8↵9↵A↵B↵C↵D↵E↵F↵G↵H↵I↵J↵K↵L
 ↵M↵N↵O↵P↵Q↵R↵S↵T↵U↵V↵W↵X↵Y↵Z↵a↵b↵c↵d↵e↵f↵g
 ↵h↵i↵j↵k↵l↵m↵n↵o↵p↵q↵r↵s↵t↵u↵v↵w↵x↵y↵z↵:↵.↵↵

- **CHARACTER COLOR** : The On Screen Display character color is adjustable by the user.
 ↵WHITE↵YELLOW↵CYAN↵GREEN↵MAGENTA↵RED↵BLUE↵BLACK↵GRAY↵

∴

3.2.4.5 MOTION SETUP.

MOTION SETUP				
	POWER ON	MOTION	AUTO	OFF
	SENS	MD.NUM	RE	DET
CH1:	70	03	64	OFF AREA
CH2:	70	03	64	OFF AREA
CH3:	70	03	64	OFF AREA
CH4:	70	03	64	OFF AREA

BUZZER ALARM TIME: 3 SEC
RELAY OUT TIMER: 8 SEC
FREEZE HOLD TIMER: 30 SEC

Figure 5.

- **POWER ON MOTION AUTO OFF (ON)** : After power on auto disable all motion (OFF setting) or enable all motion (ON setting).
- **SEN (Sensitivity)** : Control Threshold value. Range: 10 ~ 99, 99 has a higher sensitivity rate than 10.
- **MD.NUM (Detected window No.)** : Number of detected window. Range: 04 ~ 45.

FOR EXAMPLE :

※ When MD.NUM is set to "04" – to enable motion detection function there should be more than 4 motion detection windows.

※ When MD.NUM is set to "15" – to enable motion detection function there should be more than 15 motion detection windows.

- **RE (Refresh time)** : Reference Image Change time, Motion velocity control. Range 01 ~ 99,
- **DET** : The motion detection from Camera 1~4 is adjustable by disabling motion (OFF setting) or enabling motion (ON setting).
- **AREA** : The motion detection window settings for each Camera. Total of 192 (16 column×12 row) motion windows can be set.
- ◆ Press the {←} and {→} buttons to move the red bar to AREA item.
- ◆ Press the {PLAY} function key to enter the AREA (motion detect windows) setup.
- ◆ Pressing the {←} and {→} buttons to change the cursor (pink window) left and right. By pressing it more then 1 sec., allows the cursor to change quickly left and right.
- ◆ Pressing the {+} or {-} buttons to change the cursor up and down. By pressing it more then 1 sec., allows the cursor to change quickly up and down.

- ◆ Button 《AUTO》 are used for enabling (green window) or disabling (limpid windows) a detected window. By pressing it more then 1 sec., allows the value to enable or disable by more then once.
- ◆ Button《QUAD》are used for enabling (green windows) or disabling (limpid windows) the rows of the detected windows (it is done per row). By pressing it more then 1 sec., allows the value to enable or disable by more then once.
- ◆ Button 《PLAY》 is used for enabling (green window) or disabling (limpid windows) all detected windows. By pressing it for more then 1 sec., allows the value to be enabled or disabled by more then once.
- ◆ Button 《MENU》 is to leave AREA setup.
- **BUZZER ALARM TIME** : The buzzer time depends on the time period that has previously been set. (Time range : 0~240 second.)
 - ※ If the BUZZER ALARM TIME is set to 0, this function is **disabling**.
- **RELAY OUT TIMER** : The RELAY OUT activation depends on the time period that has previously been set. (Time range : 8~120 second.)
- **VCR FREEZE HOLD TIME** : The processor will automatically release freeze image after the time period that was set elapses. (Time range : 0~30 seconds.)
 - ※ If the VCR FREEZE HOLD TIME is set to 0, this function is **unavailable**.

3.2.4.6 PIP\POP SETUP.

PIP.POP SETUP					
	TYPE	SON	POSITION	SIZE	
CH1:	OFF				
CH2:	PIP	3	X:15 Y:7	A	
CH3:	PIP	1	X:14 Y:7	B	
CH4:	POP				

Figure 6.

- **PIP\POP SETUP**: Set the PIP or POP for each channel on full screen display. ⇄OFF⇄PIP⇄POP⇄
- ※ The son display of PIP on full screen: CH1 (2,3,4), CH2 (1,3,4), CH3 (1,2,4), CH4 (1,2,3)
- ※ The son display position setting range: X=0~15, Y=0~7.

3.2.4.7 LOAD DEFAULT & WATCH ALARM LIST.

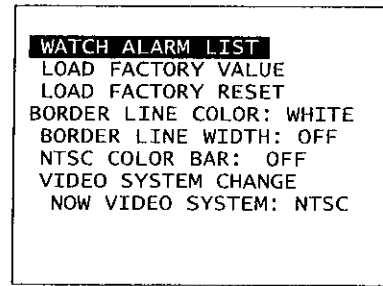

Figure 7.

- ◆ Press the <←> and <→> buttons to move the red bar up and down. By pressing it more than 1 sec., allows the cursor to move quickly up and down.
 - ◆ Buttons <+> or <-> is used for increasing or decreasing a value. By pressing it more than 1 sec., allows the value to increase or decrease by more than one value.
 - ◆ After the value is set, press the <←> and <→> buttons one last time to finalize the set-up or to disengage. To leave this set-up menu, just press the <NEXT PAGE> key one last time.
- **WATCH ALARM LIST:** List of alarm event records.

1. Press the <←> and <→> buttons to move the red bar to WATCH ALARM LIST item.
2. Press the <+> or <-> buttons to enter the watch alarm list (This menu is read only!).

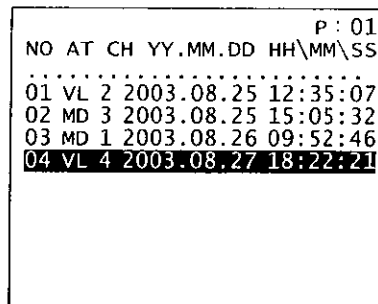

Figure 8: Alarm event records.

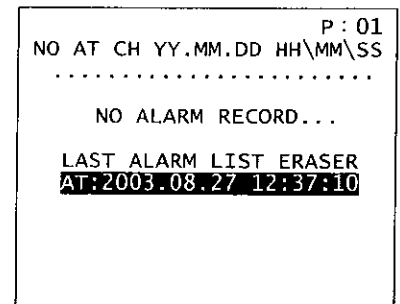

Figure 9: Alarm message after Load Default & Clear Alarm List operation.

3. Press the <+> or <-> buttons to skip to the front or next page.
4. Press the <NEXT PAGE> button to leave this watch alarm list page.

※The alarm list format:

- 0~40 : Number of event.
- P01~P05 : Alarm list page number.
- CH : Active channel.
- AT : Active Type. (MD : Motion Detect, VL : Video Loss.)
- DATE : Alarm active date.
- TIME : Alarm active time.

- **LOAD FACTORY VALUE** : All system settings will eventually return to the initial factory default settings. (When this operation has been completed, the ' . ' will be displayed).
- **LOAD FACTORY RESET** : All system settings will eventually return to the initial factory default settings and clear all alarm list records. (When this operation has been completed, the ' . ' will be displayed on **LOAD FACTORY RESET**)
- **BORDER LINE WIDTH** : The border line width settings is adjustable by user. ↔OFF↔4↔8↔16↔32↔64↔128
- **BORDER LINE COLOR** : The On Screen Display border line is adjustable by the user.
↔WHITE↔GRAY↔BLACK↔BLUE↔RED↔MAGENTA↔GREEN↔CYAN↔YELLOW↔
- **COLOR BAR** : For calibrating the monitor.
If now video system (format) is NTSC=> shown NTSC COLOR BAR : OFF
Else => shown PAL COLOR BAR : OFF
- **VIDEO SYSTEM CHANGE**: Switch NTSC/PAL system.
After the video system (format) changed, the monitor out is still showing this manual page!

4. WARNING

1. Keep away from moisture, fire, and vibration. Do not remove the covers on the camera and monitor control to avoid the risk of electric shock.
2. Keep the temperature between -10°C~50°C, relative humidity lower than 85%.
3. Keep the unit under ventilation. Don't put anything on the top of this processor. Do not expose to extreme moisture, please turn off the power and send this processor to a repair center.
4. RELAY OUT, Alarm Inputs, Video Loss and Buzzer alarm timing diagram.

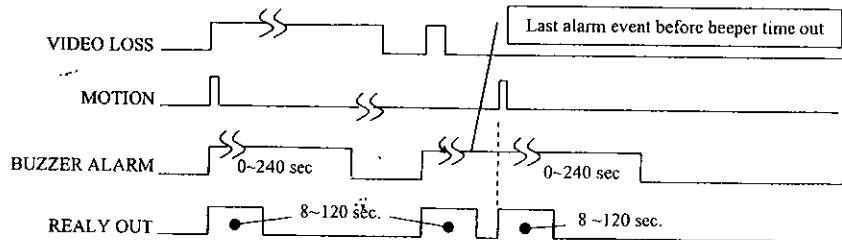

5. Please do not use any accessories that are not supported by us. It is strictly prohibited to insert any other plug into DC IN socket, please use the specified DC12V±5% / 1.0A power adapter. Otherwise, it may cause system damage, and result in injury.
6. The maximum of timer inaccuracy difference for RELAY OUT TIMER & BUZZER ALARM TIME is one second.

5. SPECIFICATIONS

(Note: Design and specifications are subject to change without prior notice.)

Video Input Ports	4 Cameras.
Picture Refresh Rate	NTSC : 60 Fields / sec ; PAL : 50 Fields / sec
Video Format	NTSC or PAL
Video Input	4 BNC connectors. 75Ω Loaded.
Video Output	2 BNC connectors.
VCR IN	1 BNC connectors. 75Ω Loaded.
Quad Out	QUAD Only video output 1 Vp.p / 75Ω Load.
Monitor Out	Full screen or Quad output 1 Vp.p / 75Ω Load.
Resolution (H×V)	NTSC : 720×480 / PAL : 720×576 pixels. (CCIR-601 Standard)
Synchronous System	Internal, Negative Synchronous.
Zoom Function	2 2 Zoom.
Timer Generator	Built-in Real Time Clock.
Title Generator	Up to 8 characters for each channel
Auto Sequential Dwell Time	Adjustable : 0~9 sec. (3 sec. for first system initialization)
Freeze Duration	Adjustable : 0~30 sec. (3 sec. for first system initialization)
Alarm Buzzer Timing	Adjustable : 0~240 sec. (3 sec. for first system initialization)
Alarm Relay Out	Normal Open / Normal Close Adjustable : 8~120 sec; 8 sec. For first system initialization.
Power Supply	DC 12V±10% / 500mA @Normal operation! (1.0A max. @ Power On Reset!)
Power Consumption	6.0 Watt. (Max.)
Dimension : W×H×D	218mm (W) ×44mm (H) ×204mm (D)
Operating Temp.	-10 ~ +50°C (14 ~ 122°F)